



							
stopper 63-88	73-74	75-76	76	77-78	77	87-88	88

absperre- leitsysteme | sistema eliminacode | barriers

**DREHER**  
MESSEBAUSYSTEME

DREHER Messebausysteme | Bergacker 1 | D-74906 Bad Rappenau-Bonfeld  
Fon +49 (0) 70 66 - 85 73 | Fax +49 (0) 70 66 - 87 25 | [info@messebau-dreher.de](mailto:info@messebau-dreher.de)

# stopper

## personenleitsysteme

gurt oder seil, modern oder klassisch? wählen sie aus dem grossen angebot von stopper personenleitsystemen ihre ausführung. mit den stopper accessoires weitere vorteile sichern. stopper ist die richtige entscheidung für alle die wissen wo's lang geht.

## sistemi guidalinee

nastro oppure cordone, moderno oppure classico? scegliete ciò che più preferite dal nostro ricchissimo programma di guidalinee stopper. assicuratevi inoltre ulteriori vantaggi espositivi grazie alla linea di accessori. stopper è la scelta giusta per tutti quelli che sanno dove andare.

## crowd control

belt or rope, modern or classic? the large assortment of stopper will provide you with the crowd control you are looking for. gain further advantage and ensure efficiency with stopper accessories. stopper: have it your way!





stopper



## Stopper<sup>®</sup> transporter

**DE** stopper das personenleitsystem von kunstdünger entwickelt und produziert, überzeugt kunden weltweit. wo immer menschen zusammenkommen ist stopper im einsatz: flughäfen, bahnhöfe, kaufhäuser, theater, kinos, museen, stadien, messen, kultur- oder sportveranstaltungen, sowie natürlich bei post, bank, versicherungen und behörden aller art. dabei übernimmt stopper zwei aufgaben: leiten und sichern. strukturieren und führen sie die wartenden und sichern sie zugleich privatsphäre z.b. am schalter. verhindern sie ausserdem unbefugtes betreten von nicht-öffentlichen bereichen. das sortiment wird von uns ständig weiterentwickelt. dieser katalog hat über 500 mögliche standard-kombinationen für sie zur auswahl. ungewöhnliche materialien, neue farben oder die personalisierung von gurt und basis mit digitaldruck sind kein problem. fragen sie uns, wir beraten sie gerne.

**IT** stopper è il sistema guidalinee eliminacode sviluppato e prodotto da kunstdünger che sta ricevendo ampi consensi dalla clientela mondiale. ovunque ci sia da dirigere dei flussi di persone, stopper entra in azione: aeroporti, stazioni, centri commerciali, teatri, cinema, musei, stadi e durante manifestazioni culturali e sportive, ma anche in posta, in banca, presso le assicurazioni e in tutti gli uffici pubblici. in questi casi stopper si assume due funzioni: direzione e sicurezza. strutturate e dirigete il flusso di persone in attesa garantendone allo stesso tempo il diritto alla privacy, come per esempio succede agli sportelli. inoltre potete impedire l'accesso a luoghi interdetti al pubblico. la già vasta gamma viene ampliata continuamente. con il presente catalogo siamo già in grado di fornirvi oltre 500 possibilità di combinazioni standard, a vostra scelta, grazie ai materiali insoliti, ai nuovi colori e alla personalizzazione del nastro e della base con la stampa digitale. siamo inoltre volentieri a disposizione per ulteriori consigli e suggerimenti.

**EN** customers worldwide choose stopper the crowd control system developed and produced by kunstdünger. wherever people come together, stopper is used: airports, railway stations, department stores, theaters, cinemas, museums, stadiums, fairs, cultural or sporting events as well as post offices, banks, insurers and offices of public authorities. on the job stopper serves two purposes: guiding and safeguarding. with stopper you guide and control the queue and guarantee privacy at the counter as well. furthermore stopper helps you to prevent trespassing into private areas. we continuously enhance the assortment. this catalogue offers you more than 500 possible standard combinations to choose from. exceptional materials, new colours or customizing of webbings and bases with digital printing is no problem. we are looking forward to your particular request.







stopper



**DE** was macht stopper aus? **die gurtkassette:** aus bruchstärkerem abs ohne schrauben und klebstoff montiert. an das 4-wege-gehäuse können sie weitere stopper anschliessen ohne zusätzliche adapter. alle hervorstehenden teile und sichtbaren kanten sind gerundet: keine verletzungsgefahr, kleidung kommt nicht zu schaden. **die feder:** eigens für stopper haben wir eine stahl-flachfeder mit abgerundeten kanten entwickelt. ihre federwirkung verläuft linear. der zug auf den gurt wirkt immer gleichmässig. das heisst für sie: kein umfallen der pfosten durch zu starken zug bei vollauszug und ausreichende spannung auch bei geringem gurtabszug. mit stopper nutzen sie die gesamte gurtlänge von 3m optimal. **die bremse:** die eingebaute fliehkraftbremse passt ihre bremsstärke an die rotationsgeschwindigkeit des mechanismus an. das gurtband wird von anfang bis ende mit gleicher geschwindigkeit eingezogen. keine hand- und fingerverletzungen durch unkontrollierte ausschläge des bandes beim einzug. **der verschluss:** jedes gurtband hat einen verschluss mit sicherung. diese sicherung rastet ein und verhindert unbeabsichtigtes auslösen oder herausgleiten. zum öffnen genügt ein knopfdruck. diese sicherung ist standard bei allen gurtausführungen. noch mehr vorteile des stoppersystems finden sie auf den nächsten seiten.

**IT** cosa compone lo stopper? **il meccanismo avvolginastro:** in abs infrangibile, si monta senza l'utilizzo di viti o colle, mentre senza bisogno di ulteriori utensili il raccordo a 4 direzioni rende possibile l'aggiunta di altri stopper. tutte le parti visibili del raccordo e degli agganci sono senza spigoli, con forme rotondeggianti: per evitare ogni possibile ferita o danno agli abiti. **la molla:** appositamente per lo stopper abbiamo realizzato una speciale molla piatta in acciaio, con gli angoli arrotondati. il suo effetto si svolge linearmente su tutta la lunghezza del nastro. ciò significa che le colonnine rimangono stabili anche quando il nastro viene utilizzato per tutta la sua lunghezza e che il nastro stesso rimane perfettamente in tensione anche se usato solo per parte della sua lunghezza. con stopper avete la possibilità di utilizzare l'intera lunghezza di 3m in modo ottimale. **il sistema frenante:** integrato nel meccanismo, il freno regola la sua azione frenante in base alla velocità di rotazione dell'avvolginastro. il nastro viene riavvolto con la stessa velocità dall'inizio alla fine. si evitano così ferite alle mani e alle dita a causa di un riavvolgimento incontrollato e troppo veloce. **il gancio di sicurezza:** ogni nastro stopper è dotato di uno speciale gancio con una chiusura di sicurezza. il gancio si incastra sul raccordo del meccanismo ed impedisce che il nastro si stacchi inavvertitamente. per aprirlo basta premere leggermente il bottoncino. tale chiusura è standard in tutti i nastri disponibili. nelle prossime pagine troverete ulteriori vantaggi che vi offre il sistema stopper.

**EN** what makes stopper exceptional? **the housing:** made of breakproof abs plastics mounted ungummed and without screws. connect more stoppers to the 4-way housing without further adaptor necessary. all jutting parts and edges are rounded: no risk of injury, no damage to clothing. **the spring:** especially for stopper we designed a steel flat spring with linear resilience. the tape is under a constant tension. that means no toppling of the posts when the tape is completely moved out and enough tension even with little pullout to keep the tape straight. with stopper you use the full tape length of 3m. **the brake:** the integrated brake adjusts its force according to the rotation speed of the mechanism. the tape is pulled back with the same speed over the full length. no sudden punches of the tape and no risk to injure hand or fingers. **the locking:** every tape has a tamper-proof locking. this locking snaps in and prevents from unintended opening or sliding out. to open just press the button. this locking comes with all tape ends as a standard. find more stopper advantages on the following pages.



personenleitsysteme | sistema eliminacode | crowd control

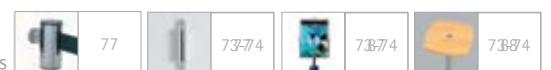





stopper

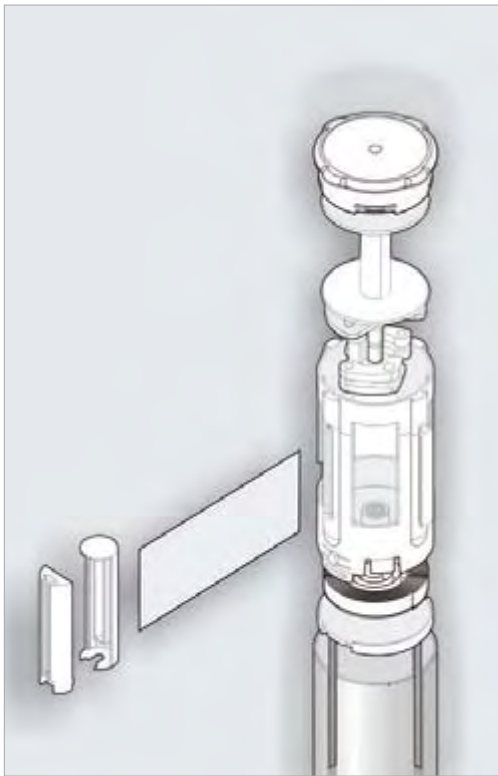

## Stopper<sup>®</sup> transporter

**DE** neue materialien, neue trends? mit stopper kein problem. bei uns finden sie auch ungewöhnliche kombinationen wie die aluminiumausführung mit einer basis aus satiniertem glas. stopper ist ein modulares system. einzelteile können gewechselt werden. die gurtgehäuse werden in den standpfosten einfach eingeschoben und rasten in die entsprechenden lochbohrungen ein. durch knopfdruck öffnet sich der verschluss und das gurtgehäuse kann entnommen und ausgetauscht werden. jedes gurtgehäuse hat ein m8 schraubgewinde. hier werden die accessoires befestigt. sie finden prospekt- und posterhalter, acrylglasschilder oder tische im zubehörprogramm. auf den folgenden seiten finden sie alles für ihr persönliches stopper-system..

**IT** nuovi materiali, nuove tendenze? nessun problema con il nostro stopper. nel nostro programma troverete insolite combinazioni come per esempio la colonna color alluminio con la base in vetro satinato. stopper infatti è un sistema modulare e componibile: ogni singola parte è intercambiabile. il meccanismo avvolginastro viene inserito nel tubo e incastrato nei fori laterali. premendo i bottoncini il meccanismo si stacca dall'incastro e può venir sostituito facilmente. ogni meccanismo è dotato di una filettatura M8, dove è possibile agganciare gli accessori. ci sono porta-informazioni, porta-cataloghi in acrilico e un tavolino, tutti accessori facili da usare, per personalizzare il vostro sistema stopper, e di cui troverete maggiori informazioni nelle prossime pagine.

**EN** new materials, new trends? no problem with stopper. we provide you also with exceptional combinations as aluminium post and satined glass base. stopper is a modular system. single parts are interchangeable and compatible. the tape housings are simply inserted into the posts. they snap in safely. open the locking by pressing the button and take out and replace the housing easily. every housing has a M8 thread to mount the accessories. choose brochure and poster holder, acrylic sign or tables out of the stopper assortment. on the following sides you will find everything to create your personal stopper system.



stopper





stopper



**DE** vielfalt, flexibilität, sicherheit: das modulare stopper-system. die basis besteht aus einem abs-trittschutz-ring, stahlplatten für sicheren stand und dekorscheiben in diversen ausführungen. der besondere clou sind die dekorscheiben aus sicherheitsglas: mit digitaldruck schnell personalisiert, auch für kurzfristige aktionen oder events zu gestalten. wir bieten ihnen ausserdem eine basis komplett aus sicherheitsglas, die in kombination mit eloxiertem aluminium ihre elegante wirkung nicht verfehlt. ihr wunsch-stopper ist im standard-programm nicht dabei? fragen sie uns, wir haben die lösung!

**IT** molteplicità d'uso, flessibilità e sicurezza: tutto questo è il sistema modulare e componibile stopper. la base è composta da un rivestimento esterno e di protezione in abs, da piastre in acciaio per dare stabilità al sistema e da inserti centrali decorativi in diverse finiture. il punto forte e la novità assoluta sono gli inserti centrali in vetro:facili e veloci da personalizzare grazie alla stampa digitale, rendono il sistema stopper adatto anche a promozioni e ad eventi di breve durata. inoltre vi offriamo anche una base completamente realizzata in vetro temperato di sicurezza che, in combinazione con il tubo in alluminio anodizzato, non mancherà di far notare il suo effetto di preziosa eleganza. lo stopper dei vostri sogni non fa parte del ricco programma in queste pagine? domandate pure, noi abbiamo la risposta!

**EN** variety, flexibly, security: the modular stopper-system. the base is composed by a step-on protection ring made of abs plastics, steel-plates for firm standing and decorative plates in divers versions. exceptional are the decorative plates made of tempered glass: with digital printing easily customised, also for for short-run promotion or events mostly suitable. furthermore we offer a base completely made of tempered glass, evolving elegant decorativeness in combination with anodized aluminium. your favoured stopper is not in the standard assortment? just ask, we have the answer!

**Stopper**  
transporter

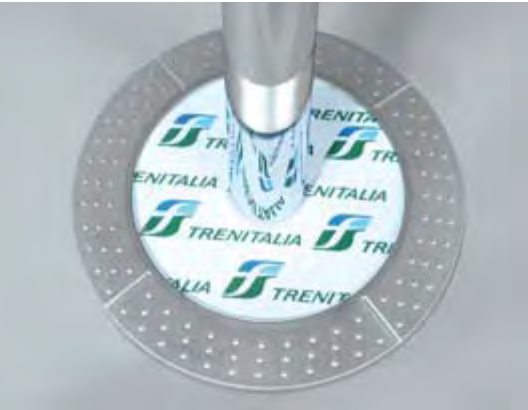
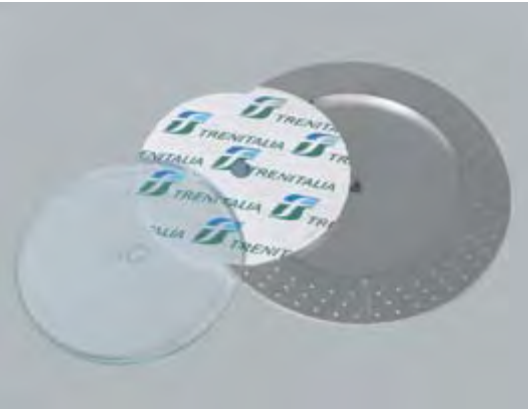

personenleitsysteme | sistema eliminacode | crowd control



stopper

auf anfrage / su richiesta/on demand

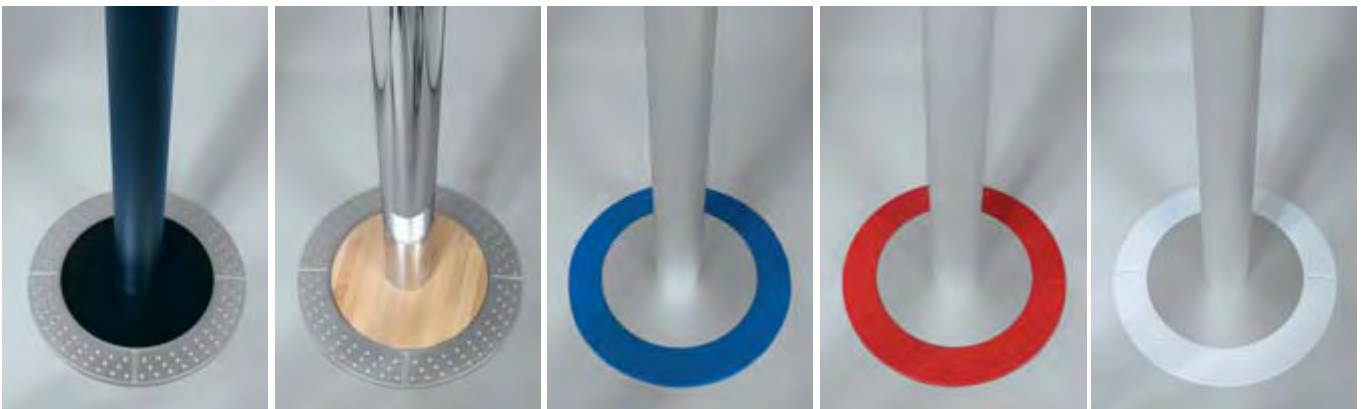



stopper



**blaues** gurtgehäuse aus bruch-sicherem abs, inkl. 3m gurtband und M8 gewinde für das zubehör

meccanismo avvolginastro in abs di colore **blu**, con foro filettato sulla parte superiore e già comprensivo del nastro lungo 3m

**blue** housing made of shock-resistant abs plastics, incl. 3m M8 thread for accessories



art. **STGHB**L

**blaues** gurtgehäuse aus bruch-sicherem abs, inkl. M8 gewinde für das zubehör  
meccanismo avvolginastro in abs di colore **blu**, con foro filettato sulla parte superiore  
**blue** housing made of shock-resistant abs plastics, incl. M8 thread for accessories



art. **STGHS**Z

**schwarzes** gurtgehäuse aus bruch-sicherem abs, inkl. M8 gewinde für das zubehör  
meccanismo avvolginastro in abs di colore **nero**, con foro filettato sulla parte superiore  
**black** housing made of shock-resistant abs plastics, incl. M8 thread for accessories



**schwarzes** gurtgehäuse aus bruch-sicherem abs, inkl. 3m gurtband und M8 gewinde für das zubehör

meccanismo avvolginastro in abs di colore **nero**, con foro filettato sulla parte superiore e già comprensivo del nastro lungo 3m

**black** housing made of shock-resistant abs plastics, incl. 3m webbing and M8 thread for accessories



schwarz/nero/black



blau/blu/blue



rot/rosso/red



grau/grigio/grey

**DE** das abs-gurtgehäuse wird in den pfosten eingeschoben und rastet sicher ein. zum austausch die verschlussfeder einfach per knopfdruck öffnen und gehäuse herausziehen. das gurtband aus synthetischem gewebe ist strapazierfähig und farbecht. nutzen sie die volle gurtlänge von 3m bei einer höhe von 5cm und 0,7mm dicke. gerne personalisieren wir den gurt nach ihren vorgaben mit siebdruck. lesen sie mehr über die technik der gurtkassette auf s. 65.

**IT** il meccanismo avvolginastro in abs viene inserito nel tubo grazie alle scanalature laterali e al sistema autobloccante. per cambiare il meccanismo basta sganciare le molle grazie ai bottoncino laterali ed estrarlo. il nastro di tessuto sintetico è robusto e non scolorisce; alto 5 cm e con uno spessore minimo, di soli 0,7 mm, il nastro è utilizzabile per tutta la sua notevole lunghezza, 3 metri. su vostra indicazione è possibile personalizzare il nastro, con una stampa serigrafica. a pagina 65 troverete ulteriori informazioni e dettagli sulla composizione tecnica del meccanismo avvolginastro.

**EN** the housing made of abs plastics is simply inserted into the post and locks in safely. for changing just press the button to open and pull out the housing. the sturdy and colour fast webbing is made of synthetic fabric. 5cm high and 0,7mm thick the tape can be fully extracted to 3m. customising the webbing according to your needs with silkscreen printing is no problem. find more technical details about the housing on page 65.







## Stopper<sup>®</sup> transporter

**DE** hier haben wir die gängigsten stopper-modelle für sie zusammengestellt. sie wählen die kombination kassette/gurtband und basis/pfosten. ihr wunschmodell ist nicht dabei? auf den nächsten seiten finden sie noch mehr.

**IT** in questa pagina vi presentiamo i modelli più comuni della linea stopper. scegliete la combinazione che preferite di meccanismo/nastro e di base/tubo. non trovate il modello desiderato? ci sono ulteriori modelli nelle prossime pagine.

**EN** on this page we compiled the most popular combinations for you. just choose the combination housing/tape and base/post. can't find your preferred option? find more on the next pages.

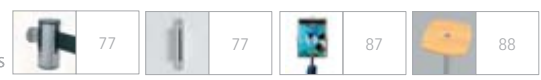

				
	schwarz/nero/black STGH12065BSW	blau/blu/blue STGH12065BBL	rot/rosso/red STGH12065BRT	grau/grigio/grey STGH12065BGR
				
	schwarz/nero/black STGH12065SSW	blau/blu/blue STGH12065SBL	rot/rosso/red STGH12065SRT	grau/grigio/grey STGH12065SGR

stopper

abs silber/argento/silver silber/argento/silver	abs schwarz/nero/black messing/ottone/brass	abs schwarz/nero/black schwarz/nero/black	abs silber/argento/silver chrom/cromo/chrome
STKARAR	STKSWOT	STKSWSW	STARCM
			

abs silber/argento/silver alu/alluminio/aluminium	glas/vetro/glass alu/alluminio/aluminium	abs silber/argento/silver glas-chrom/vetro-chromo/glass-chrome
STKARAL	STVEAL	STKARVEAL
		





**DE** stellen sie sich ihren stopper zusammen:  
 A gurtmechanismus + B pfosten + C dekorscheibe + D trittschutzring  
 für die basis aus glas bestellen sie nur ST330VE ohne C dekorscheibe.  
 \*) auf anfrage

**IT** componete il vs. stopper:  
 A meccanismo avvolginastro + B tubo + C inserto centrale + D protezione in abs  
 per la base in vetroordinate ST330VE senza C inserto centralec.  
 \*) a richiesta

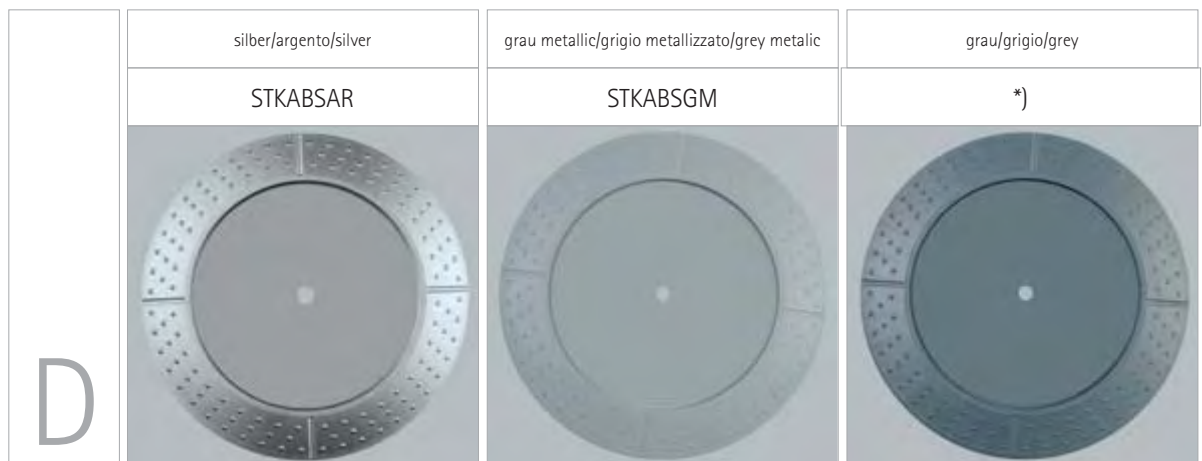

**EN** create your favoured stopper:  
 A housing + B post + C insert + D abs protection  
 for the base in glass just order ST330VE without C insert.  
 \*) on demand

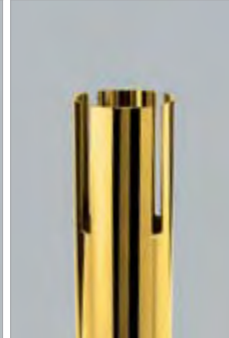

A					
		schwarz/nero/black	blau/blu/blue	rot/rosso/red	grau/grigio/grey
		STGH12065BSW	STGH12065BBL	STGH12065BRT	STGH12065BGR
					
		schwarz/nero/black	blau/blu/blue	rot/rosso/red	grau/grigio/grey
		STGH12065SSW	STGH12065SBL	STGH12065SRT	STGH12065SGR

B	silber/argento/silver	aluminium/alluminio	chrom/cromo/chrome	messing/ottone/brass	schwarz/nero/black
	ST980AR	ST980AL	ST980CM	ST980OT	ST980SW
					

chrom/cromo/chrome	messing/ottone/brass	schwarz/nero/black	glas/vetro/glass
STKINSAR	STKINSOT	STKINSSW	STKINSVE
			

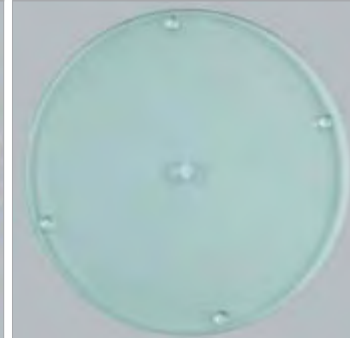
schwarz/nero/black	rot/rosso/red	blau/blu/blue	glas/vetro/glass
STKABSSW	*)	*)	ST330VE
			





stopper **wandhalterung** hochglanz verchromt STWH130CM oder silbermatt veredelt STWH130AR, inkl. schrauben und dübel für die wandmontage

**attacco a parete** in cromo lucido STWH130CM oppure in argento satinato STWH130AR, comprensivo di viti e tasselli per il montaggio

**stopper wall mount** high-gloss chrome-plated STWH130CM or silver satined STWH130AR, incl. screws and dowels for mounting



STWC90 stopper **wandclip** messing vernickelt inkl. schraube und dübel für die wandmontage

**stopper clip a muro** in ottone nichelato, comprensiva di viti e tasselli per il montaggio

**stopper wallclip**, nickel-plated brass, incl. screws and dowels for mounting

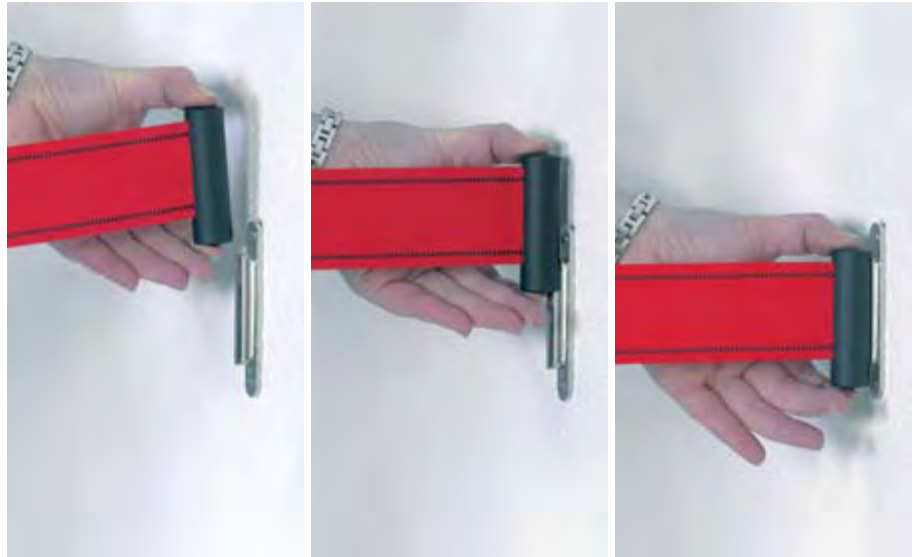

**DE** ohne pfosten und basis: die stopper wandhalter. mit der wandhalterung in chrom oder silber nutzen sie alle vorteile des stopper-systems. montieren sie die halterung platzsparend in durchgangsbereichen. gurtkassette einschieben, fertig. auch mit der wandhalterung steht ihnen das komplette 4-wege system von stopper zur verfügung. nicht nur die auszüge parallel und rechtwinklig zur montagefläche, sondern auch der 4. auszug rückseitig. den 4. auszug setzen sie dann ein, wenn sie die wandhalterung verdeckt montieren. hinter trockenbauwänden oder in möbeln installiert, macht sich stopper nur im bedarfsfall bemerkbar. als festen gegenpart befestigen sie den wandclip oder nutzen einen weiteren mechansimus mit wandhalter. selbstverständlich können sie den absperrgurt auch an einem mobilen stopper-pfosten anschliessen.

**IT** attacco a parete stopper : grazie alle due versioni, in argento satinato e in cromo lucido, potrete utilizzare al meglio tutti i vantaggi che vi offre la linea stopper. gli attacchi a parete possono essere montati in luoghi dove il flusso di persone debba essere continuamente regolato, basta semplicemente fissarlo al muro e inserirvi il meccanismo avvolginastro. anche con l'attacco a parete avete a disposizione, come per lo stopper, lo stesso raccordo a 4 direzioni: non solo il nastro può uscire dall'attacco a parete frontalmente e lateralmente, ma è anche possibile utilizzare una quarta via d'uscita, posteriore, se l'attacco a parete rimane nascosto.

**EN** no post, no base: stopper wall mount. with the chrome-plated or silver satined wall mount you enjoy all advantages of the stopper system. mount the holding where areas must be regularly restricted. after mounting, insert the housing into the holding. use the 4-way system of stopper also with wall mount: you can use the pullouts forward or parallel to the wall and the 4th direction backwards as well. this direction is used when you mount the holding hidden behind walls or integrated in furniture. take the wallclip or a second wall mount as fixed counterpart. as a matter of course the tape can also be connected to a mobile stopper post.

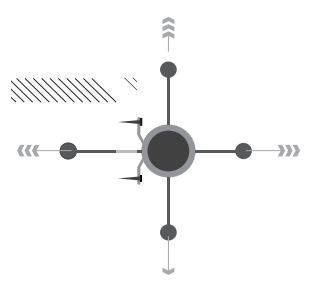



stopper tex

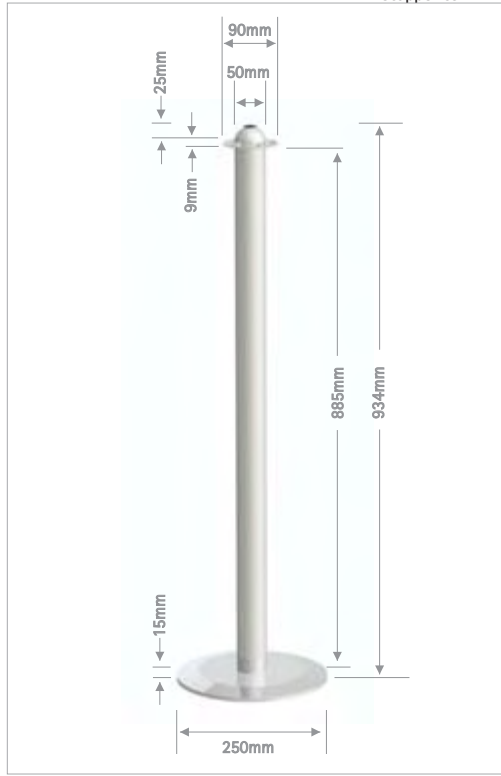

tex



**DE** stopper tex ist die klassische variante des personenleitsystems. mit den edlen materialien in hochqualitativer verarbeitung empfiehlt sich stopper tex vor allem für das elegante ambiente im empfangsbereich, in hotelfoyers, für besondere ausstellungsstücke in museen oder im showroom. der posten bietet zehn möglichkeiten die seile einzuhängen. formschöne clips machen rasten einfach und sicher ein. durch den karabiner-effekt wird unbeabsichtigtes lösen verhindert. alle stopper tex haben ein M8 gewinde passend für die elemente des stopper zubehörprogramms.

**IT** stopper tex é la variante classica del sistema guidalinee eliminacode. grazie all'utilizzo di materiali nobili e ad una lavorazione di qualità, lo stopper tex è particolarmente indicato per gli ambienti eleganti di ricevimento, come le hall di un albergo, per le mostre e le rappresentazioni in musei o teatri o anche per dare un tocco di raffinata eleganza allo showroom. stopper tex mette a vostra disposizione la possibilità di agganciare fino a 10 cordoni ad una sola colonnina. i morsetti, eleganti e funzionali, rendono l'aggancio facile e sicuro. grazie al meccanismo di sicurezza dei morsetti non è possibile che si sgancino inavvertitamente. ogni stopper tex è dotato, nella parte superiore, di un foro filettato M8 per l'utilizzo degli accessori in programma

**EN** stopper tex is the classic way of crowd control. high class material with high quality finish characterises stopper tex. especially for the elegant ambiente in reception areas or hotel foyers as well as for exceptional exhibits in museums or showrooms stopper tex is recommended. the post has ten openings to hang in the rope. shapely clips make the attaching easy and safe. the karabiner-like closing prevents from unintended opening or sliding out. all stopper tex have a M8 thread suitable for all elements of the stopper accessories assortment.

stopper tex | stopper tex | stopper tex

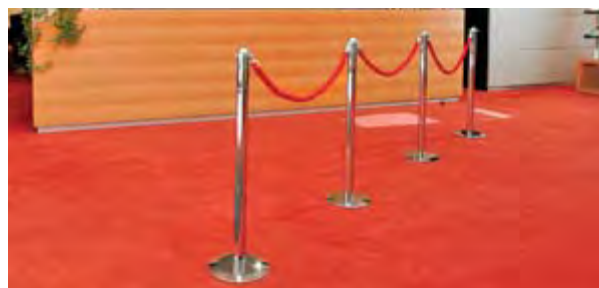



art. **TEXCM=**  
**1 TXBASECM+1 TXTUBOCM**

stopper tex hochglanz **verchromt**:  
 basis Ø250mm TXBASECM und  
 pfosten TXTUBOCM

stopper tex in **chromo lucido**:  
 base Ø250mm TXBASECM e tubo  
 TXTUBOCM

stopper tex high-gloss **chrome-  
 plated**: base Ø250mm TXBASECM  
 and post TXTUBOCM



*tex*

**Stopper**  
 transporter



art. **TEXOT=**  
**1 TXBASEOT+1 TXTUBOOT**

stopper tex hochglanz **vermessingt**:  
 basis Ø250mm TXBASEOT und  
 pfosten TXTUBOOT

stopper tex in **ottone lucido**:  
 base Ø250mm TXBASEOT e tubo  
 TXTUBOOT

stopper tex high-gloss **brassplated**:  
 base Ø250mm TXBASEOT and post  
 TXTUBOOT



**DE** formschön und hochwertig präsentiert sich stopper tex. basis und pfosten sind aus poliertem stahl. das kopfteil aus messing-drehteilen. alle teile sind hochglanz veredelt. wählen sie zwischen der farbausführung in messing oder chrom. stopper tex ist 940mm hoch und steht sicher auf der basis mit 250mm durchmesser.

**IT** elegante, raffinato e di qualità : ecco come si presenta stopper tex. la base e il tubo sono realizzati in acciaio polito. la testina superiore è invece realizzata in ottone. tutte le parti che compongono stopper tex sono rifiniti con una cromatura lucida di protezione. potete scegliere tra la versione in cromo lucido e la versione in color ottone lucido. stopper tex è alto 940 mm e poggia in modo sicuro su una base del diametro di 250 mm.

**EN** stopper tex introduces itself with elegancy and high-grade materials. base and post are made of polished steel. the sphere is composed of turned brass pieces. all parts are high-gloss finished. choose between brass- or chrome-plated. stopper tex is 940mm high and stands firmly on the base with 250mm diameter.



stopper



seilkappe hochglanz **verchromt** mit karabiner-clip, vermickelt

morsetto in  **Cromo lucido** con clip nichelata

rope connector **chrome-plated** with nickel-plated carabiner



seilkappe hochglanz **vermessingt** mit karabiner-clip, vermickelt

morsetto in **ottone lucido** con clip nichelata

rope connector **brass-plated** with nickel-plated carabiner



art. **TEXWHCM**

stopper tex wandhalter **verchromt** packg. 1st inkl. schrauben und dübel

gancio stopper tex per parete in  **Cromo lucido** conf. a 1pz incl. viti e taselli

stopper tex wallclip **chrome-plated**: package 1pc incl. screws and dowels



länge lunghezza length				
1000mm	TEXSCMSW100	TEXSCMRS100	TEXSCMBL100	TEXSCMGR100
1500mm	TEXSCMSW150	TEXSCMRS150	TEXSCMBL150	TEXSCMGR150
2000mm	TEXSCMSW200	TEXSCMRS200	TEXSCMBL200	TEXSCMGR200



länge lunghezza length				
1000mm	TEXSOTSW100	TEXSOTRS100	TEXSOTBL100	TEXSOTGR100
1500mm	TEXSOTSW150	TEXSOTRS150	TEXSOTBL150	TEXSOTGR150
2000mm	TEXSOTSW200	TEXSOTRS200	TEXSOTBL200	TEXSOTGR200

weitere längen auf anfrage / altre lunghezze disponibili a richiesta / other sizes on demand

# tex

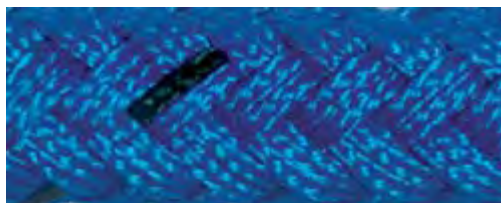

**DE** hochwertige materialien und vielfältige auswahl auch bei den seilen. speziell für stopper tex werden die seile aus polypropylen geflochten. das material ist farbecht sowie staub- und schmutzabweisend. sie können aus vier farben in jeweils drei standardlängen wählen. die seilkappe ist hochglanz vermessingt oder verchromt. der verschlusskarabiner in lackierter nickelausführung sorgt für einfache und sichere befestigung des seils.

**IT** materiali di prima qualità e ampia scelta caratterizzano anche le corde a disposizione per lo stopper tex. le corde in polipropilene vengono intrecciate appositamente per il nostro stopper tex. il materiale di cui sono composte non scolorisce ed è inoltre resistente a polvere e sporcizia. dalla nostra gamma potete scegliere 4 colori e 3 lunghezze standard. il morsetto è cromato lucido nelle finiture cromo e ottone. la clip vera e propria, nichelata, garantisce un sistema di chiusura che non può essere sganciato inavvertitamente.

**EN** stopper tex offers high-quality materials and manifold choice also for the ropes. exclusively for stopper tex the ropes are plaited in polypropylene. the material is colour fast as well as dust- and soil-resisting. the ropes come in four colours with three standard lengths. the rope connector is high-gloss chrome- or brass-plated. the rope is clipped safe and easily with the locking carabiner.

personenleitsysteme | sistema eliminacode | crowd control



# DREHER

MESSEBAUSYSTEME GmbH

DREHER MESSEBAUSYSTEME GmbH | Talstr. 3 | D-74363 Güglingen  
Tel.: +49 (0) 71 35 / 93 75 89 | Fax: +49 (0) 71 35 / 61 20 | [info@messebau-dreher.de](mailto:info@messebau-dreher.de)





**stophold** in das integrierte gewinde schrauben

avvitare il sostegno universale **stophold** nel foro filettato

screw **stophold** into the integrated thread



art. **STH250230CM**

**stophold** haltebügel, hochglanzverchromt, 230mmx250mm (hxb)

**stophold** sostegno cromo lucido, 230mmx250mm (hxb)

**stophold** display holder, high-gloss chrome-plated, 230mmx250mm (hxb)

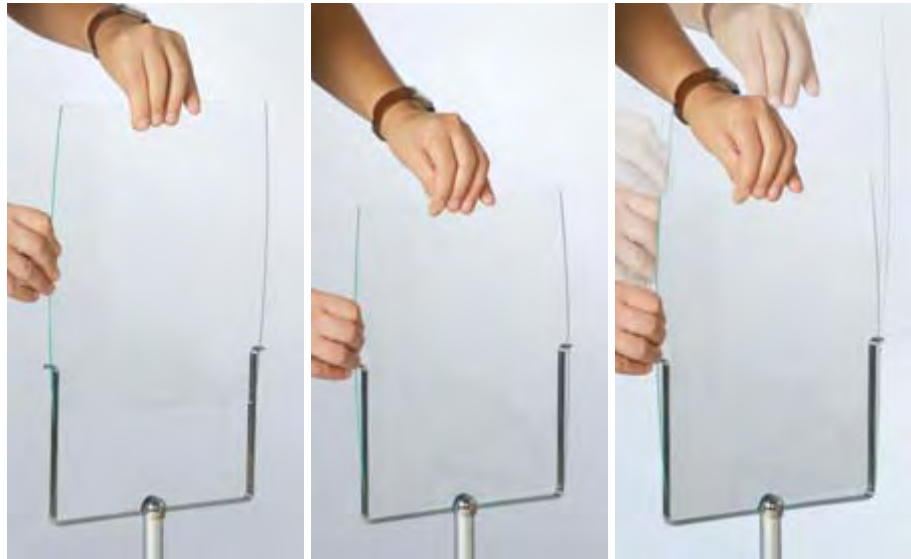

**Stopper**  
transporter



**DE** egal ob stopper, stopper wandhalter oder stopper tex mit den stopper accessoires erweitern sie ihr personenleitsystem. informieren, präsentieren oder bewerben ist mit den accessoires kein problem. der universal haltebügel stophold wird aufgeschraubt. stopper-gurtkassetten wie stopper tex haben bereits das passende gewinde. stophold passt auf alle stopper-versionen, auch die wandhalterung. das passende acrylglas-displays auswählen und einschieben. die displays können sie jederzeit wechseln. unser tip: alle stopper displays können sie auch mit flip aus der zip-linie verwenden.

**IT** che si tratti delle colonnine stopper, dell'attacco a muro o dello stopper tex, con gli accessori della nostra gamma potete moltiplicare le funzioni del vostro sistema guidalinee: informare, presentare o fare pubblicità non sono un problema. il sostegno universale ad U viene semplicemente avvitato sul meccanismo avvolginastro dello stopper o sulla testina dello stopper tex, già dotate del foro filettato per questo utilizzo. il sostegno universale è adatto per tutte le versioni, anche per quella a parete. i supporti in acrilico si inseriscono facilmente nel sostegno ad U e altrettanto facilmente possono essere cambiati in qualsiasi momento. un consiglio: tali supporti in acrilico sono compatibili anche con il nostro flip, della linea zip.

**EN** upgrade your stopper, stopper wall or stopper tex crowd control system with the accessories. informing, presenting or advertising is no problem with the stopper elements. the holder stophold is screwed on the post. stopper tape housing and stopper tex do have the matching thread. stophold fits for all stopper versions including the stopper wallmount. choose the needed acrylic glass display and insert it into stophold. you can replace the displays anytime. our special advise: all stopper acrylic displays match also with flip of the zip-assortment.



stopper



art. **STH250230CM**  
**stophold** haltebügel, hochglanzverchromt, 230mmx250mm (hxb)  
**stophold** sostegno cromo lucido, 230mmx250mm (hxb)  
**stophold** display holder, high-gloss chrome-plated, 230mmx250mm (hxb)



art. **STS30324GL**  
**acrylglas-ablage stopshelf** 3mm stark für DIN A4 format, 45° neigung, ablatetiefe 40mm  
**ripiano stopshelf** in acrilico color vetro, spessore 3mm, per formato DIN A4, inclinato di 45°, profondità del ripiano 40mm  
**stopshelf** glass-green acrylic shelf, thickness 3mm for DIN A4 format, inclination 45°, shelf depth 40mm

# accessoires



art. **STB305240GL**  
**stopbag** acrylglas prospekttasche, 3mm, DIN A4 format, 20° neigung für ca. 200 einzelblattprospekte  
**stopbag** tasca portadepliant in acrilico color vetro, spessore 3mm, per formato DIN A4, inclinata di circa 20°, adatta per circa 200 fogli singoli  
**stopbag** glassgreen acrylic brochure pocket, thickness 3mm for DIN A4 format, inclination 20° for approx. 200 single sheet brochures



art. **STU305240GL**  
**stopup** acrylglas-posterhalter 3mm stark für ein einzelblatt im DIN A4 format, 45° neigung, seitlicher einschub  
**stopup** portaposter in acrilico color vetro, spessore 3mm, per formato DIN A4, inclinato di 45°, inserimento del foglio laterale  
**stopup** glassgreen acrylic poster holder, thickness 3mm, for one single sheet in DIN A4 format, inclination 45°, insertion sideways



personenleitsysteme | sistema eliminacode | crowd control



art. STQ302240GL

**stopquick** acrylglas-posterhalter 3mm, für ein einzelblatt DIN A4 format, ein- und beidseitige ansicht, öffnung mit magnetverschluss

**stopquick** portaposter in acrilico color vetro, spessore 3mm, per formato DIN A4, con calamita per la chiusura, verticale, mono- e bifacciale

**stopquick** glassgreen acrylic poster holder, thickness 3mm, for one single sheet in DIN A4 format, vertical, front and rear view, magnetic lock



art. STF302240GL

**stopfix** acrylglas-infoschild im DIN A4 format, stehend, ein- und beidseitige ansicht, für individuelle gestaltung und beschriftung

**stopfix** pannelo per informazioni, in acrilico color vetro, spessore 3mm, per formato DIN A4, mono- e bifacciale, per cartelli di direzione e di indicazione

**stopfix** glassgreen sign in DIN A4 format, vertical, front and rear view, for individual design and print



## accessoires

**Stopper**  
transporter

art. STT400400B

**stoptable:** tischplatte, buche massiv, 400mmx400mmx20mm

**stoptable:** tavolino in faggio massiccio, 400mmx400mmx20mm

**stoptable:** desk top, solid beech wood, 400mmx400mmx20mm

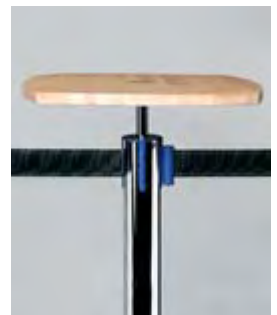

# DREHER

MESSEBAUSYSTEME GmbH